

The logo for TECE, consisting of the word "TECE" in a bold, white, sans-serif font, followed by a small square icon containing a grid pattern. The logo is set against a dark blue rectangular background.

TECE



TECE公司簡介

close to you

TECE

TECE集團

- 1987 年成立
- 總部位於德國埃姆斯代騰 (Emsdetten)
- 衛浴、管道及安裝系統的國際化生產廠商
- 全球共27個子公司 及5個生產基地
- 年銷售額3億歐元
- 約2000名員工



TECE

TECE集團



TECE活躍於全球市場
在全世界擁有27家子公司



close to you

TECE在全球有6個生產基地

德國

- Emsdetten 埃姆斯代騰
- Wuppertal 伍珀塔爾

波蘭

- Wroclaw MPC 弗羅茨瓦夫
- Wroclaw TCI 弗羅茨瓦夫

西班牙

- Castellón 卡斯特利翁
- **中國**
- Taicang 太倉

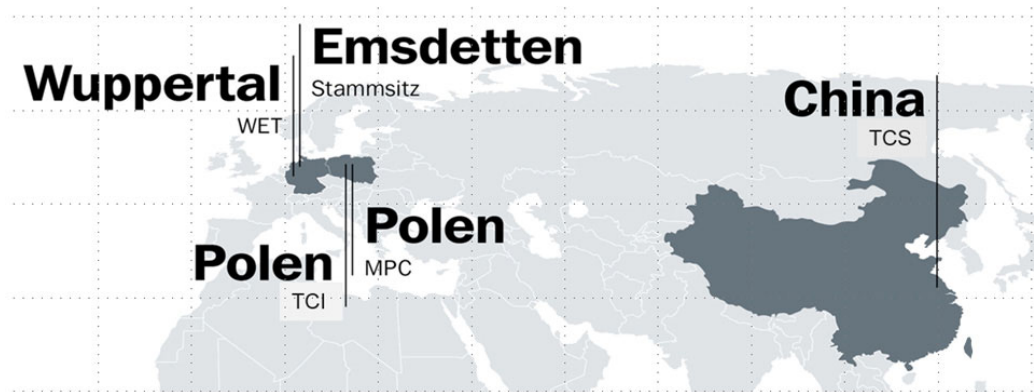

TECE

TECE中國生產基地

- 2006年11月14日成立
- 位於江蘇太倉
- 工廠面積為16,688平方米
- 約110名員工



TECE

品牌基因

認真探究市場和深度技術交流讓我們充分瞭解客戶的需求
TECE作為創新者，將這種深入的瞭解轉化為精良完善的系統方案，
為我們的客戶帶來更進一步的附加價值
我們稱之為：

TECE
close to you

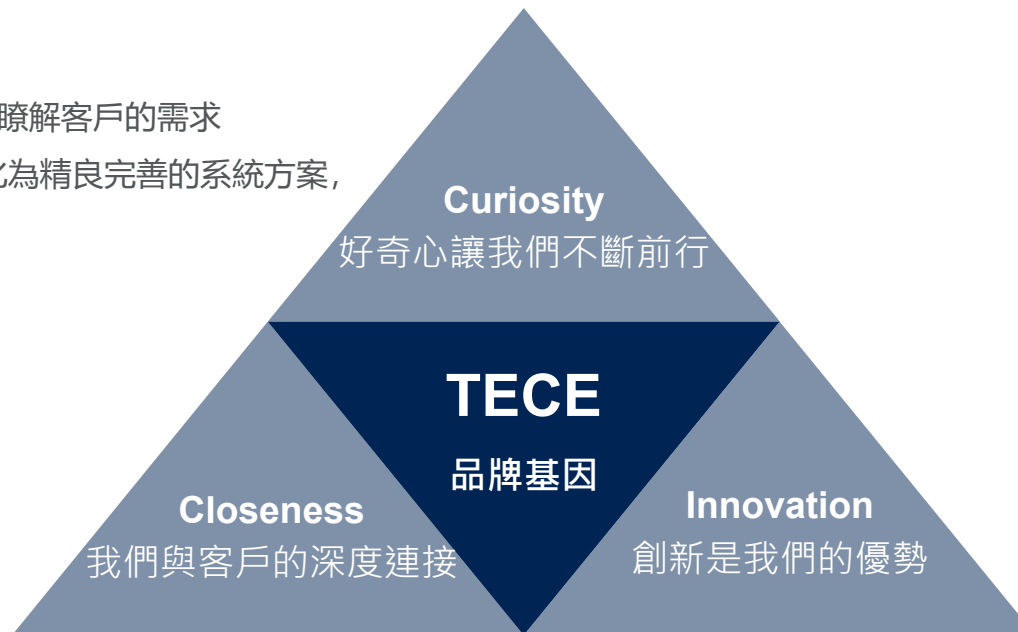

close to you

TECE

Water in, water out 安全順暢的給水與排水

TECE的核心競爭力顯而易見，就是以我們的
創新精神確保建築中安全順暢的給水與排水

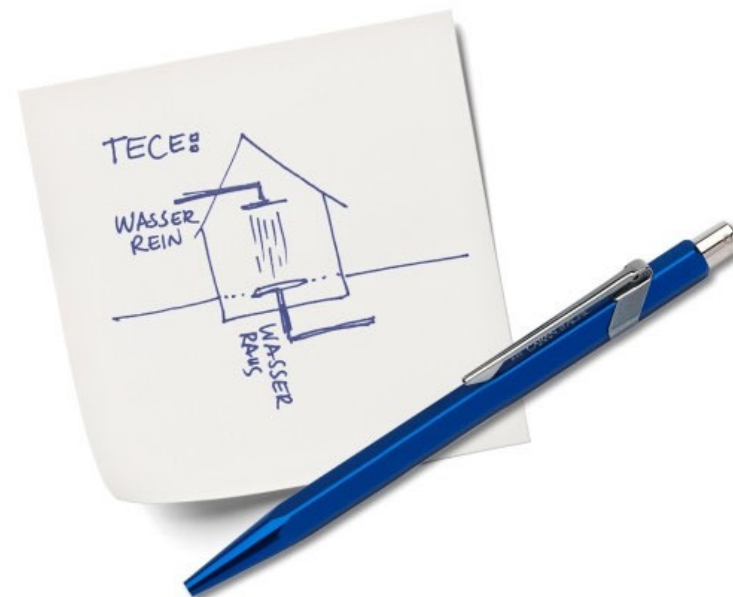

close to you

沖廁面板及小便鬥沖水面板

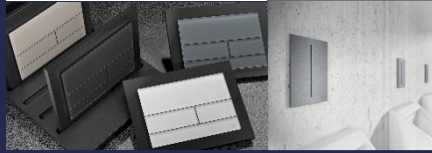

污水提升系統



鋁塑管
給水系統



隱蔽式水箱



Z275快裝
系統

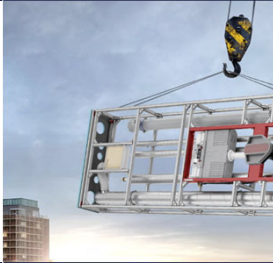

淋浴房
地漏

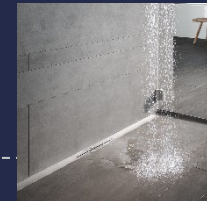

地暖系統

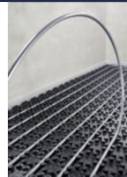

壁掛馬桶



TECE

TECE Z275快裝系統
先驅者

close to you

TECE

TECE Z275快裝系統

什麼是Z275?

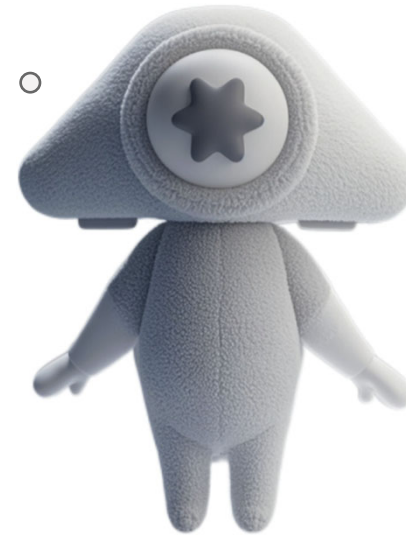

close to you

TECE

TECE Z275快裝系統

開創幹式牆體預製快裝的革命：TECE Z275龍骨誕生至今已經有三十年，立志于替代傳統磚與水泥砂漿構成的牆體，無需焊接的輕鋼龍骨，並且所有的龍骨與配件都可以重複使用，更環保



close to you

TECE

TECE Z275快裝系統 產品優勢

close to you

TECE Z275快裝系統的產品優勢

破土

放線及牆面開槽

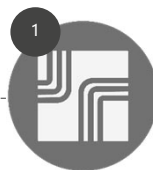

埋管

冷熱水管施工+打壓實驗

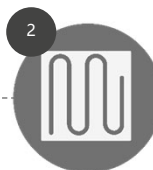

覆土

混凝土回填+養護

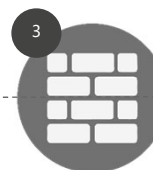

翻修

出現錯誤返修



毛裝飾面

毛面抹平



防水

防水施工及防水養護

TECE

TECE Z275快裝系統的產品優勢

工廠預製



減少施工幹濕交替等待時間，工期
相對於傳統施工可節省70%的時間

現場安裝



時間

close to you

TECE

TECE Z275快裝系統的產品優勢

無特殊工種的要求，只需要一把
手槍鑽即可進行龍骨的組裝，產
品容錯率高

人工



close to you

TECE

TECE Z275快裝系統的產品優勢

TECE Z275的型材，配件都可以重複利用，環保的前提下，也大大節省了材料的成本

材料



close to you

TECE

TECE Z275快裝系統的產品優勢



close to you

TECE

TECE Z275快裝系統 組成

close to you

TECE

TECE Z275的組成

瞭解TECE Z275預製快裝系統組成，
從而更好更正確的去使用它



TECE Z275僅需基礎的3個
配件即可組成一面牢固穩
定的預製快裝牆體



close to you

TECE

TECE Z275基礎配件

9000007直管:採用**275g/m²** 鍍鋅鋼管（鍍鋅層厚度為25μm），壁厚1mm，封閉型鍍鋅鋼，即使在火災中也可實現更全面的安全性；240小時鹽霧測試通過

9000000 進口龍骨，4.5m/根，鋼材選用的型號為S250GD

9000007 國產龍骨，3.8m/根，鋼材選用的型號為S280GD

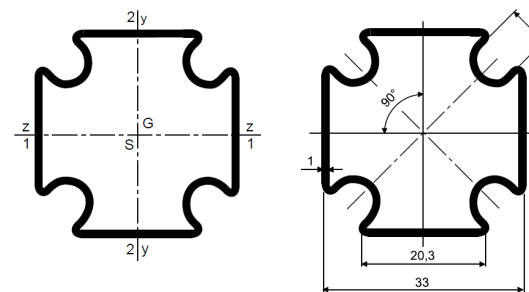

close to you

TECE

TECE Z275基礎配件

9010002角接: 連接始終自動直角
對齊，預拉伸壓縮彈簧簡化組裝，
整體金屬材料，耐火性能好

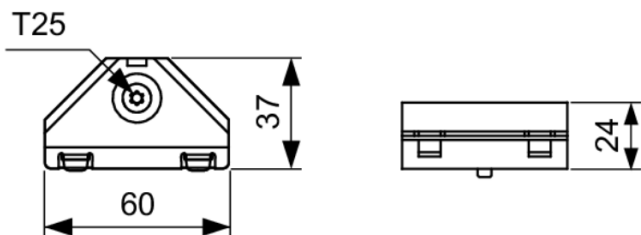

使用一把T25的梅花
螺絲刀即可完成角接
的安裝，並且自然形
成直角

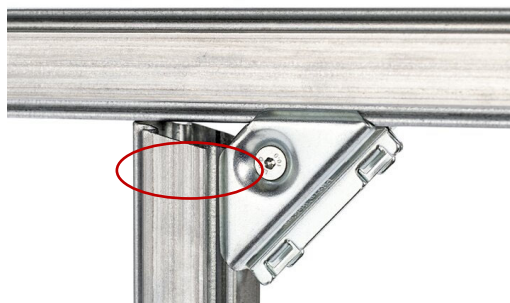

即使對角線切割的公
差達到**10毫米**，也
可以輕易的補償，對
施工的專業性要求大
大降低

TECE

TECE Z275基礎配件

9030002角固定件:用於龍骨和牆地面連接固定，並且可輕鬆調節高度和深度，允許牆面有結構公差方便用於牆面找平；另外該配件還可用於固定幹掛配件等

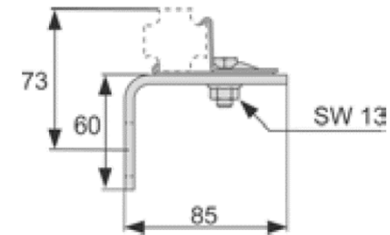

close to you

TECE

TECE Z275多種類的配件

除去標準的三個龍骨牆體配件以外，TECE為產品的應用提供了更多的配件種類，從而將牆體的應用更加多元化



close to you

TECE

TECE Z275多種類的配件

可與TECEprofil衛浴支架類產品完美連接



close to you

TECE

TECE Z275多種類的配件

TECE Z275的配件應用不局限在單一應用，將龍骨應用成樂高積木似的搭建，發揮設計師的想像力，開發出每個配件的亮點

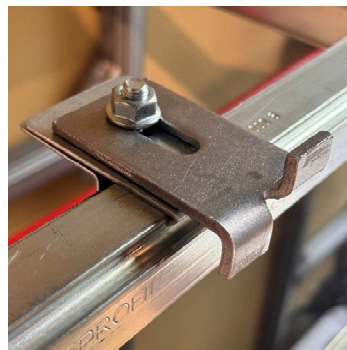

close to you

TECE







TECE Z275快裝系統 可靠性

close to you

TECE Z275的可靠性

“過五關斬六將”的測試才能成為最終的TECE Z275

每一根TECE Z275都需要滿足各種嚴苛的測試，這不光是對產品的負責，更是對每一個經銷商和消費者的負責

TECE PROFIL Test Report									
Samples Test Period: 2025/1-20-2025/1/23									
No. / Nr.	SAP Material No. / SAP Materialnr.	Material short text / Materialbezeichnung	Sample Picture / Bildobjektbild	Test Name / Testname	Test Reason/Note / Testgrund/Notiz	Test Set-Up / Versuchsaufbau	Test Requirement / Testanforderung	Test Qty	Test Result / Testergebnis
1	9000007	TECEprofil Section Tube		Dimensional inspection / Maßprüfung	Check sample against specification / Prüflist gegen Spezifikation prüfen	Determination of dimensions	Specification / Spezifikation		OK
2	9000007	TECEprofil Section Tube		Visual inspection / visuelle Prüfung	Surface, marking, weld seam / Oberfläche, Sprengring, Schweißnaht		Specification / Spezifikation		OK
3	9000007	TECEprofil Section Tube		Functional test of component combination / Funktionsprüfung Bauteilkombination	Install Tecprofil connector 9010009 in the profile tube / Tecprofil verbinder 9010009 in das Profilrohr montieren	Assembly by hand / Montage per Hand	The connector must be easy to insert and must not fall out / Verbindungsstück muss problemlos einstecken lassen und darf nicht herausfallen		OK
4	9000007	TECEprofil Section Tube		Functional test of component combination / Funktionsprüfung Bauteilkombination	Fit Tecprofil insert base 9240000 into the profile tube / Tecprofil Einsteckhilfe 9240000 in das Profilrohr einpassen	Assembly by hand / Montage per Hand	It must be possible to insert the clip - fast easily and it must not fall out. / Einsteckhilfe muß sich problemlos einstecken lassen und darf nicht herausfallen		OK
5	9000007	TECEprofil Section Tube		Functional test of component combination / Funktionsprüfung Bauteilkombination	Install Tecprofil sleeve bracket 9020000 in the profile tube / Tecprofil Doppelhülse 9020000 in das Profilrohr einpassen	Assembly by hand / Montage per Hand	It must be possible to push the insertion foot into a position with manual force / Einbaufuß muß sich in einer Position mit Handkraft einschieben lassen		OK
6	9000007	TECEprofil Section Tube		Functional test of component combination / Funktionsprüfung Bauteilkombination	Mount Tecprofil multi-clamp 9010003 on the profile tube / Tecprofil Multiklemme 9010003 auf das Profilrohr montieren	Assembly by hand / Montage per Hand	It must be possible to mount the multi-clamp in one position with a perfect fit / Multiklemme muß sich mit einwandfreier Sitz in allen Position montieren lassen		OK
7	9000007	TECEprofil Section Tube		Functional test of component combination / Funktionsprüfung Bauteilkombination	Mount Tecprofil multi-clamp 9020000 on the profile tube / Tecprofil Multiklemme 9020002 auf das Profilrohr montieren	Assembly by hand / Montage per Hand	It must be possible to mount the multi-clamp in one position with a perfect fit / Multiklemme muß sich mit einwandfreier Sitz in allen Position montieren lassen		OK



close to you

TECE

TECE Z275的可靠性



9010002出廠需通過900N (90公斤) 的拉力測試, 實測極限承重為1800N (180公斤)

TECE

TECE Z275的可靠性



9030002, 9030011, ,9030013,
9018002 (牆地固定件與雙管連
接件) 出廠需要通過4000N
(400公斤) 的拉力測試, 實測極
限拉力為6300N (630公斤)

TECE

TECE Z275的可靠性

9000000龍骨型材都會通過72小時,100
小時, 144小時, 240小時階段性鹽霧
測試

(中性鹽霧測試24小時相當於自然環境
中1年)

在鹽霧測試當中龍骨表面出現的白色物
質為鍍鋅層的氧化物質，只要沒有出現
銹蝕的顏色就能保證龍骨型材的牢固度



TECE龍骨在鹽霧測試
240小時下的狀態



TECE龍骨在鹽霧測試
100小時下的狀態



國內仿品在鹽霧測試
100小時下的狀態

TECE Z275的可靠性

9000000龍骨型材原材料分析

以下是该产品（TECEprofil200mm）与国内常见镀锌钢标准（以 SGCC 为例，日标镀锌商用钢板）的成分对比表：

元素	该产品含量 (%)	SGCC 标准上限 (%)	对比结论
C	0.13	≤0.15	符合标准，低碳利于成形
Si	0.021	≤0.5	远低于上限，不影响镀锌层
Mn	0.54	≤0.8	处于合理区间，强度塑性平衡
S	0.0038	≤0.03	远低于上限，杂质控制优秀
P	0.021	≤0.05	低于上限，脆性风险低
Al	0.039	无明确上限（通常≤0.05）	处于合理脱氧剂范围

C: 碳 Si: 矽 Mn: 錳 S: 硫 P: 磷 Al: 鋁

TECE

TECE Z275的可靠性

埠徑向荷載測試——當
變形量為10mm時，徑
向力為 $\geq 4000\text{N}$
焊縫無撕裂

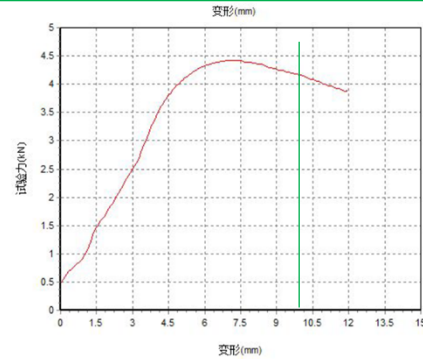
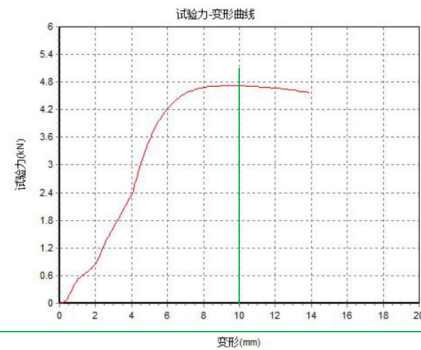
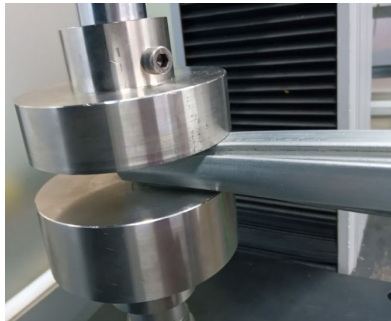

TECE Z275

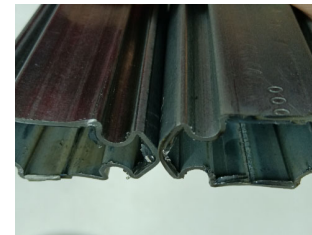

國內仿製產品

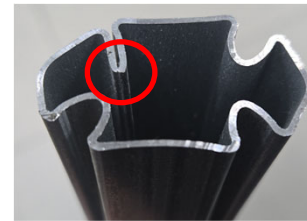

TECE產品徑向載荷測試合格，國內仿製產品**焊縫撕裂**

TECE

TECE Z275的可靠性

埠膨脹測試—— 4000N的軸向力下，焊縫不得撕裂



TECE Z275

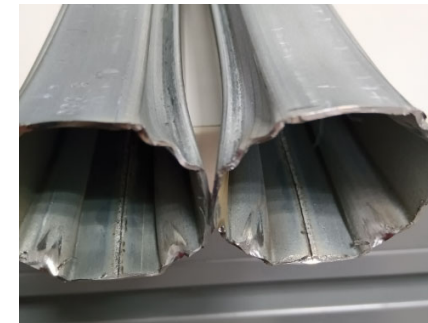
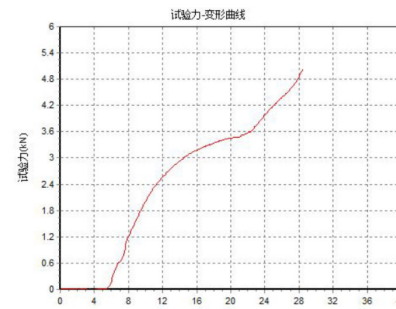

國內仿製產品

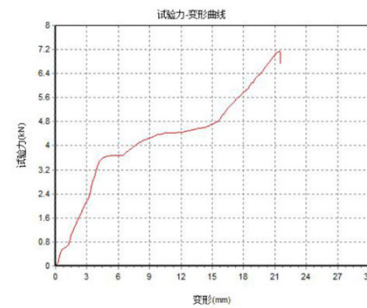

TECE產品埠膨脹測試合格，國內仿製產品焊縫撕裂

close to you

TECE

TECE Z275的可靠性

EOTA 權威標準——室內牆體： 安全性測試： 柔性衝擊測試使用 50kg 衝擊體， 1 次衝擊， 能量 100-500Nm； 剛性衝擊測試 使用 1kg 鋼球， 1 次衝擊， 能量 10Nm。 適用性測試： 柔性衝擊測試使用 50kg 衝擊體， 3 次衝擊， 能量 60-400Nm； 剛性衝擊測試使用 0.5kg 鋼球， 3 次衝擊， 能量 1.3-6Nm



EOTA 是歐洲技術批准組織 (European Organisation for Technical Approvals) 的縮寫，是一個非盈利組織，致力於協調歐洲建築產品技術評估的工作，以促進建築產品在整個歐洲範圍內的自由流通。EOTA 是唯一被歐盟委員會授權進行歐洲技術評估的機構，其評估結果被歐盟各成員國普遍接受

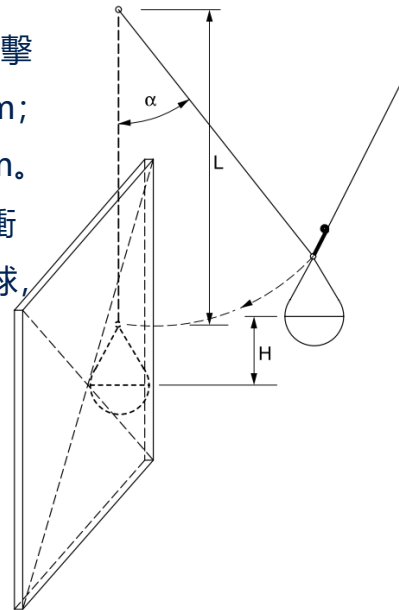

Figure 2 – Impact on vertical assembly
 h = drop height; L = length rope; α = 65°



close to you

TECE

TECE Z275快裝系統 應用

close to you

TECE

TECE Z275的應用

TECE Z275龍骨牆可以應用在家裝各個位置

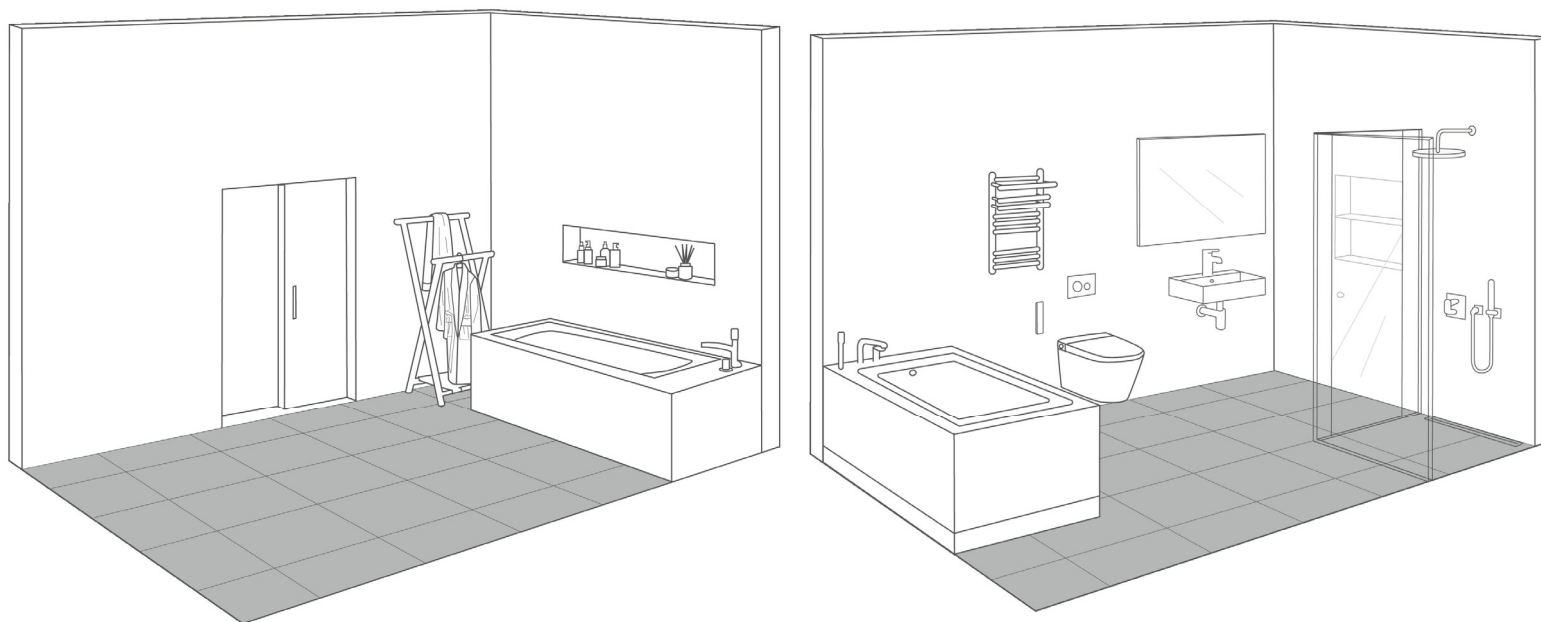

close to you

TECE

TECE Z275的應用

龍骨應用——雙層牆

所有龍骨牆都可以將給水管，排水管，電線管都安裝到牆內無需再牆上進行開槽，並且結合TECEprofil支架系統可以完美的解決衛生間幹濕交替施工的問題，大大節約時間成本和人工成本

使用各種隔音材料與保溫材料填充牆體可以滿足不同隔音需求

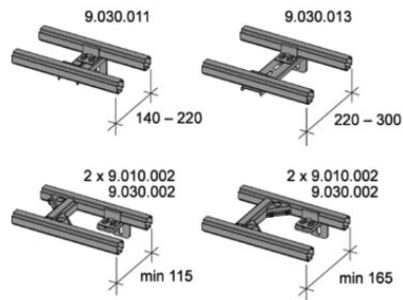

close to you

TECE

TECE Z275的應用

龍骨應用——單層牆

單層龍骨牆可用于傳統牆面找平，空間隔斷。在將牆體盡可能做薄的情況下兼顧穩定與強度

TECE Z275包含各種閥芯固定底座可更加標準化的預埋花灑等各種閥芯



close to you

TECE

TECE Z275的應用

龍骨應用——浴缸支架

龍骨與嵌入式浴缸的結合更加體現出了龍骨的靈活性，配合不同尺寸與樣式的浴缸，龍骨可以成為100%適配的浴缸支架，根據浴室空間合理規劃擺放好浴缸，並且方便預留檢修口



close to you

TECE

TECE Z275的應用

龍骨應用——口袋門

設計師喜歡的口袋門利用龍骨的穩定性及內部空間可利用的優點，輕鬆實現安裝簡單後期維修方便的口袋門牆體



close to you

TECE

TECE Z275的應用

龍骨應用——壁龕

利用龍骨牆中空結構的特點可將任何位置的牆面做成帶收納功能或者展示功能的壁龕或者鏡櫃，大大增加了牆體的利用率



close to you

TECE

TECE Z275的應用

龍骨應用——“樂高積木”

發揮想像力，不局限于傳統牆體的應用，在TECE Z275各種強大的參數支持下，實現各種場景的搭建，從而將TECE Z275變的更強大



close to you

TECE

TECE Z275的應用

TECE smartwall——任何時間任何地點的專業設計

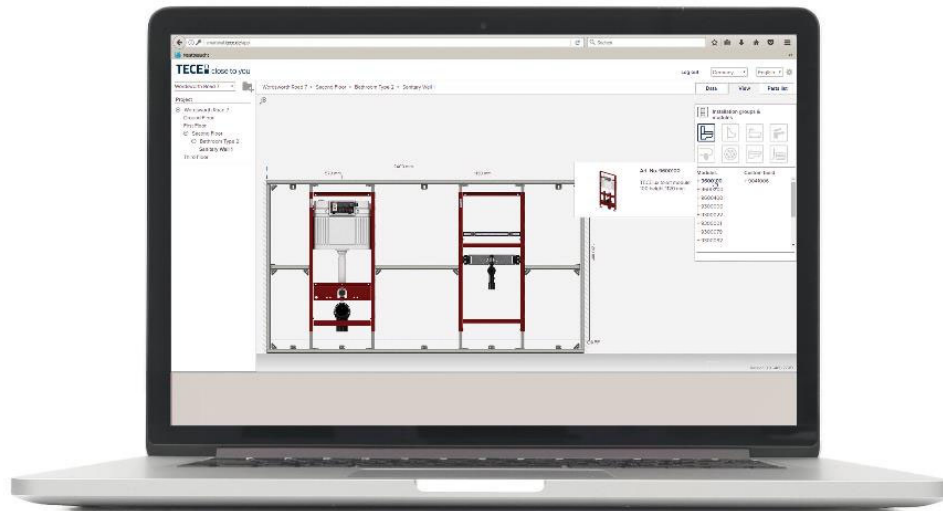

<https://smartwall.tece.de>

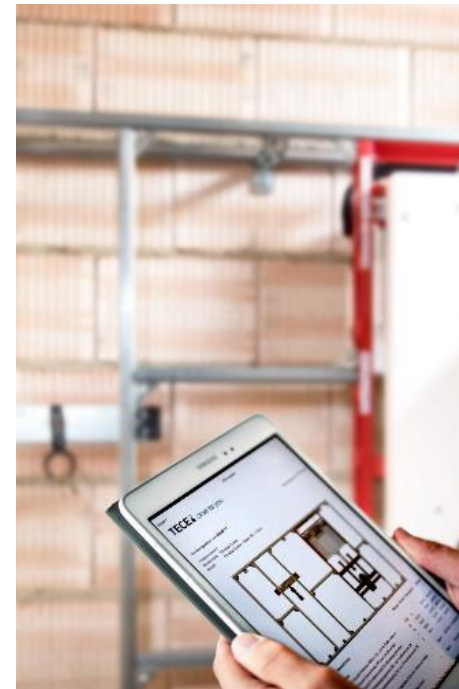

close to you

TECE

TECE Z275快裝系統 項目案例

close to you

TECE

TECE Z275的項目預製化

所有牆體的最終目標就是實現預製化的快速安裝



close to you

TECE

TECE Z275的項目案例

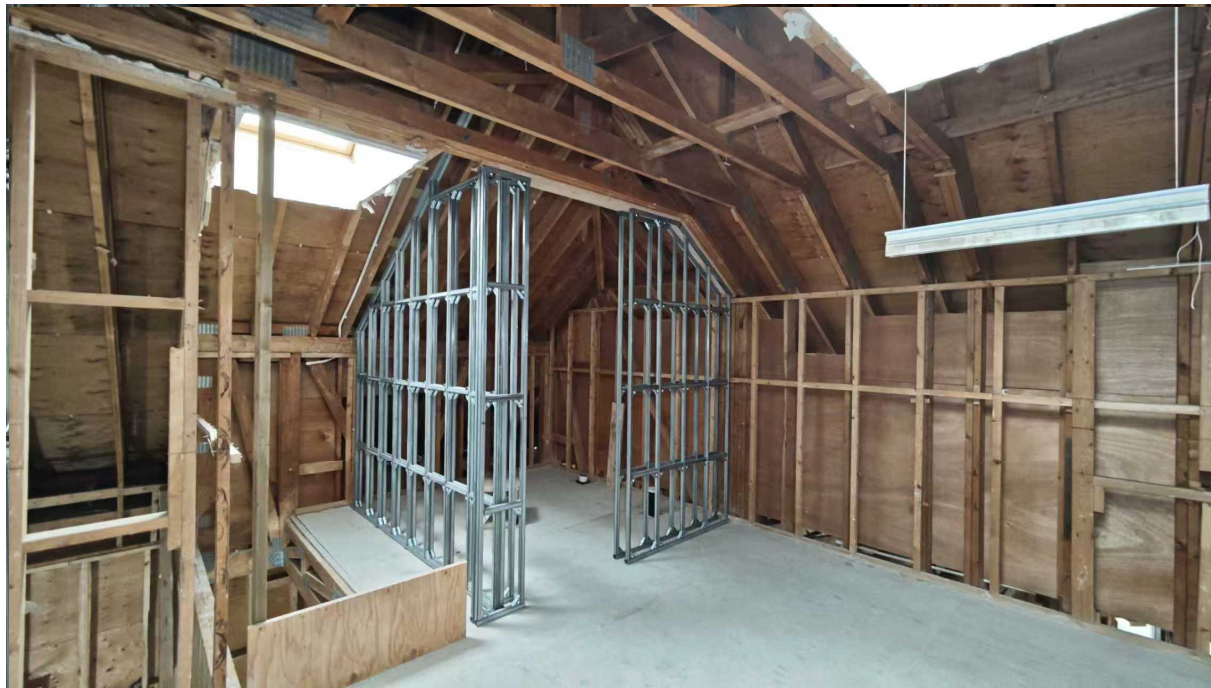

上海一臻園

TECE

TECE Z275的項目案例

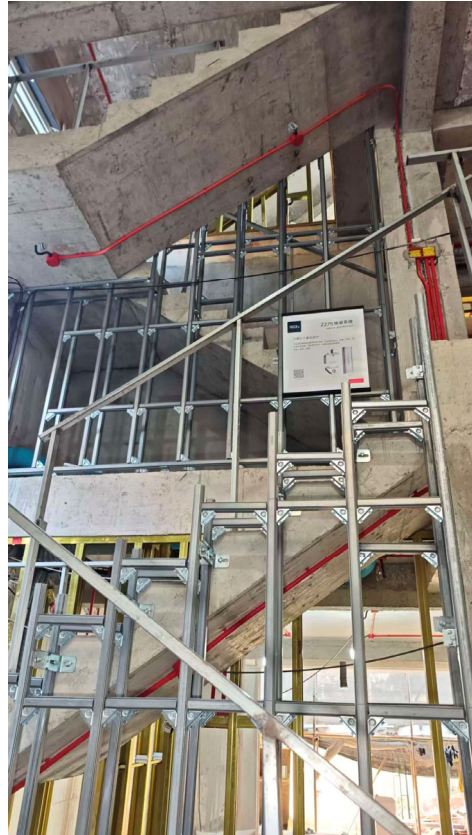
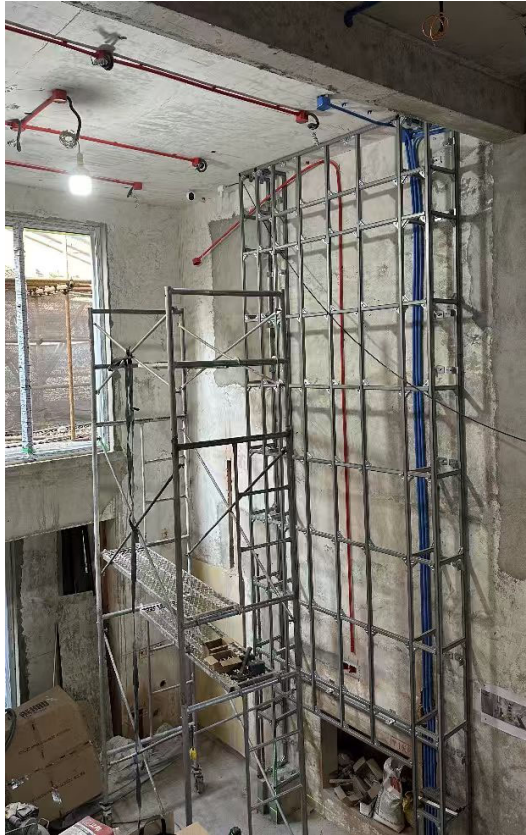

保利葉語

close to you

TECE

TECE Z275的項目案例



德國一科隆學生公寓

TECE

TECE Z275的項目案例



德國一般格翰公寓

close to you

TECE

TECE Z275的項目案例



印度—艾哈默德巴德觀景台酒店

close to you

TECE

TECE Z275的項目案例



德國—美因茨·賓根地區行政大樓

TECE

TECE Z275的項目案例



德國—杜塞爾多夫the niu Hub酒店

close to you

TECE

TECE Z275的項目案例



西班牙—馬德里四季酒店

close to you

TECE 
close to you



TECE

歡迎關注



公眾號



視頻號



抖音



小紅書

close to you

TECE

掃碼獲取TECE Z275樣冊



close to you

TECE
close to you



02-27978761
04-24220159
0989-171435

黃淮治